

31.25

62.5

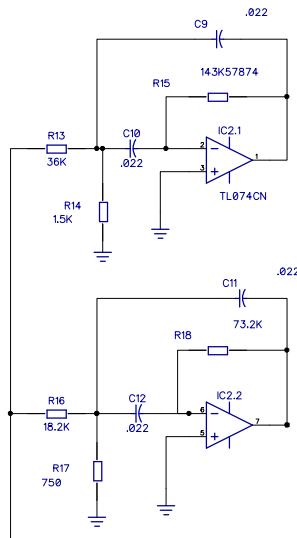

500

1000

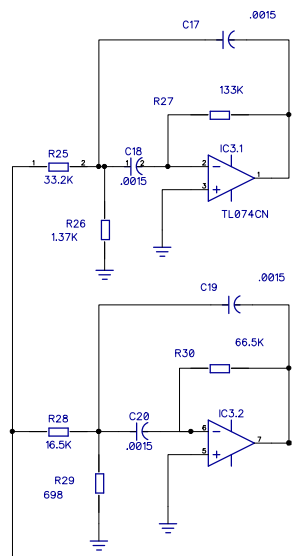

8000

16000

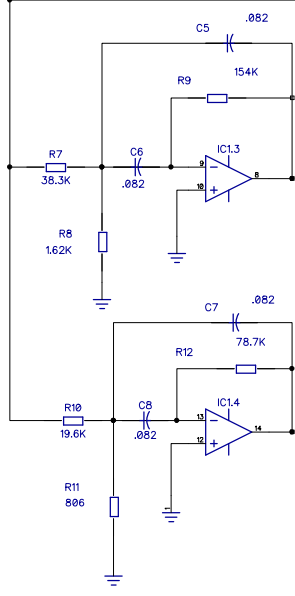
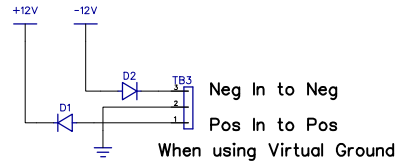
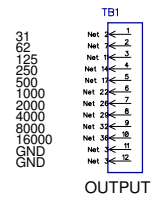
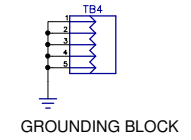

125

250

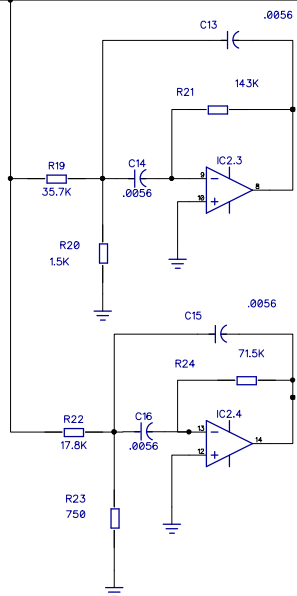

2000

4000

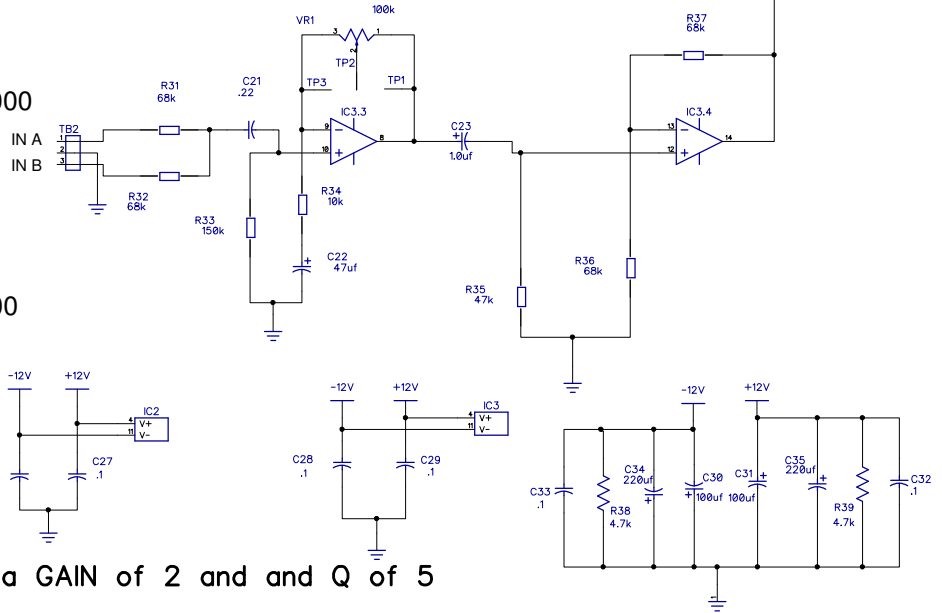

Above filter values will give a GAIN of 2 and and Q of 5